

## DESCRIPTION

DKG-225, is a low cost AMF controller for 12V gensets, featuring an internal battery charger. Internal fuel and crank relays are rated at 40Amps@12V-DC and do not require external relays.

Thus a typical transfer panel will simply consist on one DKG-225 and two contactors, reducing material cost, panel size and production time.

The unit supports also current transformer connections allowing detailed power measurements from both mains and genset sides. The standard unit supports 1A and 5A secondary CTs. A special version supports low cost and small 0.1A secondary CTs allowing more compact panel design.

Thanks to the DKG-225, automatization of small gensets has become easy and cost effective.

In AUTO position, the unit monitors 3 phases of the mains, runs and stops the genset automatically and performs load transfer. When the engine is running, it monitors internal protections and alarm inputs.

The 1Amp @12V-DC rated battery charger is sufficient for the float charging of the engine start battery.

Timers, threshold levels, input and output configurations are digitally programmable. Programs are modified through front panel pushbuttons and do not require an additional unit.

The fault conditions are considered in 2 categories as Warnings and Alarms. Measured values have separate programmable limits for warning and alarm conditions.

The unit is designed for front panel mounting. Connections are made with 2 part plug and socket connectors.

# DKG-225

## AUTOMATIC MAINS FAILURE UNIT WITH INTERNAL CHARGER

## FEATURES

- **Automatic mains monitoring**
- **Automatic load transfer**
- **Automatic starting and stopping**
- **Automatic stopping in fault condition**
- **Gas engine support**
- **Test mode available**
- **Emergency backup mode**
- **3 phase mains voltage inputs**
- **3 phase genset voltage inputs**
- **3 phase mains/genset CT inputs**
- **2 configurable analog sender inputs**
- **3 configurable digital inputs**
- **Detailed AC measurements and protections**
- **Internal battery charging rectifier**
- **40 Amp rated Fuel and Crank outputs**
- **Front panel adjustable parameters**
- **Stop, preheat and choke output capability**
- **Survives cranking voltage dropouts**
- **Compact dimensions, panel mounted**

## MEASUREMENTS

Mains Volts: L1-N, L2-N, L3-N, L1-L2, L2-L3, L3-L1  
 Genset Volts: L1-N, L2-N, L3-N, L1-L2, L2-L3, L3-L1  
 Load Currents: L1, L2, L3  
 Load total kW, kVA, kVAr, cosφ  
 Genset Frequency  
 Battery Voltage  
 Oil pressure  
 Coolant temperature  
 Engine run Hours  
 Service Counters



## COPYRIGHT NOTICE

Any unauthorized use or copying of the contents or any part of this document is prohibited.

## ABOUT THIS DOCUMENT

This document describes minimum requirements and necessary steps for the successful installation of the DKG-225 family units.

Follow carefully advices given in the document. These are often good practices for the installation which reduce future issues.

For all technical queries please contact Datakom at below e-mail address:

**datakom@datakom.com.tr**

## QUERRIES

If additional information to this manual is required, please contact the manufacturer directly at below e-mail address:

**datakom@datakom.com.tr**

Please provide following information in order to get answers to any question:

- Device model name (see the back panel of the unit),
- Complete serial number (see the back panel of the unit),
- Firmware version (read from the display screen),
- Measuring-circuit voltage and power supply voltage,
- Precise description of the query.

## REVISION HISTORY

REVISION	DATE	WRITTEN	DESCRIPTION
01	08.11.2016	MH	First edition

## TERMINOLOGY



**CAUTION:** Potential risk of injury or death.



**WARNING:** Potential risk of malfunction or material damage.



**ATTENTION:** Useful hints for the understanding of device operation.

**SPARE PARTS**



Screw Type Bracket  
Stock Code=J10P01 (1 unit)



Spring Type Bracket  
Stock Code=K16P01 (1 unit)



Watertight Gasket, Stock Code= K96P01



### SAFETY NOTICE

Failure to follow below instructions will result in death or serious injury



- Electrical equipment should be installed only by qualified specialist. No responsibility is assured by the manufacturer or any of its subsidiaries for any consequences resulting from the non-compliance to these instructions.

- Check the unit for cracks and damages due to transportation. Do not install damaged equipment.



- Do not open the unit. There are no serviceable parts inside.



- Fuses must be connected to phase voltage inputs, in close proximity of the unit.

- Fuses must be of fast type (FF) with a maximum rating of 6A.



- Disconnect all power before working on equipment.



- When the unit is connected to the network do not touch terminals.

- Short circuit terminals of unused current transformers.



- Any electrical parameter applied to the device must be in the range specified in the user manual. Although the unit is designed with a wide safety margin, over-range parameters may reduce lifetime, alter operational precision or even damage the unit.



- Do not try to clean the device with solvent or the like. Only clean with a damp cloth.

- Verify correct terminal connections before applying power.

- Only for FRONT panel mounting.



**WARNING:** Use of fuses of higher rating than allowed may result in serious hazards.



Current Transformers must be used for current measurement. No direct connection allowed.

---

## TABLE OF CONTENTS

- 1. INSTALLATION INSTRUCTIONS**
- 2. MOUNTING**
  - 2.1 DIMENSIONS
  - 2.2 SEALING, GASKET
  - 2.3 ELECTRICAL INSTALLATION
- 3. TERMINAL DESCRIPTIONS**
  - 3.1. BATTERY VOLTAGE INPUT / OUTPUT
  - 3.2. AC VOLTAGE INPUTS
  - 3.3. AC CURRENT INPUTS
  - 3.4. DIGITAL INPUTS
  - 3.5. ANALOG SENDER INPUTS
  - 3.6. CHARGE INPUT TERMINAL
  - 3.7. MAINS CONTACTOR OUTPUT
  - 3.8. GENERATOR CONTACTOR OUTPUT
  - 3.9. DIGITAL OUTPUTS
- 4. CONNECTION DIAGRAM**
- 5. TERMINAL DESCRIPTION**
- 6. TECHNICAL SPECIFICATIONS**
- 7. DESCRIPTION OF CONTROLS**
  - 7.1. FRONT PANEL FUNCTIONALITY
  - 7.2. PUSHBUTTON FUNCTIONS
  - 7.3. DISPLAY SCREEN ORGANIZATION
  - 7.4. MEASURED PARAMETERS
  - 7.5. LED INDICATORS
- 8. OPERATION OF THE UNIT**
  - 8.1. QUICK START GUIDE
  - 8.2. STOP MODE
  - 8.3. MANUAL RUN MODE
  - 8.4. AUTO MODE
- 9. PROTECTIONS AND ALARMS**
  - 9.1. SERVICE REQUEST ALARM
  - 9.2. ALARMS
- 10. PROGRAMMING**
- 11. CRANK CUTTING**

**TABLE OF CONTENTS (continued)****12. SOFTWARE FEATURES****12.1. REMOTE START OPERATION****12.2. MAINS SIMULATION****12.3. DELAYED MAINS SIMULATION, BATTERY CHARGING****12.4. SERVICE REQUEST DISPLAY****12.5. ENGINE HOUR METER****12.6. SOFTWARE VERSION DISPLAY****12.7. GAS ENGINE FUEL SOLENOID CONTROL****12.8. SINGLE PHASE OPERATION****13. DECLARATION OF CONFORMITY****14. MAINTENANCE****15. DISPOSAL OF THE UNIT****16. ROHS COMPLIANCE****17. TROUBLESHOOTING**

## 1. INSTALLATION INSTRUCTIONS

### Before installation:

- Read the user manual carefully, determine the correct connection diagram.
- Remove all connectors and mounting brackets from the unit, then pass the unit through the mounting opening.
- Put mounting brackets and tighten. Do not tighten too much, this can brake the enclosure.
- Make electrical connections with plugs removed from sockets, then place plugs to their sockets.
- Be sure that adequate cooling is provided.
- Be sure that the temperature of the environment will not exceed the maximum operating temperature in any case.

### Below conditions may damage the device:

- Incorrect connections.
- Incorrect battery voltage.
- Reverse battery voltage
- Voltage at measuring terminals beyond specified range.
- Voltage applied to digital inputs over specified range.
- Current at measuring terminals beyond specified range.
- Overload or short circuit at relay outputs
- Excessive vibration, direct installation on vibrating parts.

### Below conditions may cause abnormal operation:

- Battery voltage below minimum acceptable level.
- Frequency out of specified limits
- Missing earthing



**Current Transformers must be used for current measurement.  
No direct connection allowed.**

## 2. MOUNTING

### 2.1. DIMENSIONS

**Dimensions:** 133x107x46mm (5.25"x4.2"x1.9")  
**Panel cutout:** 117x87mm minimum (4.6"x3.43")  
**Weight:** 200g (0.45 lb)

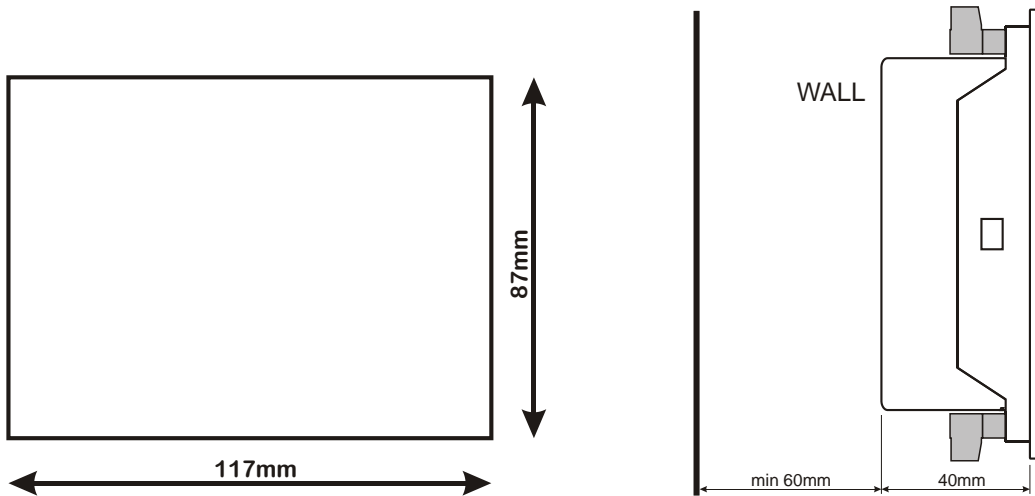
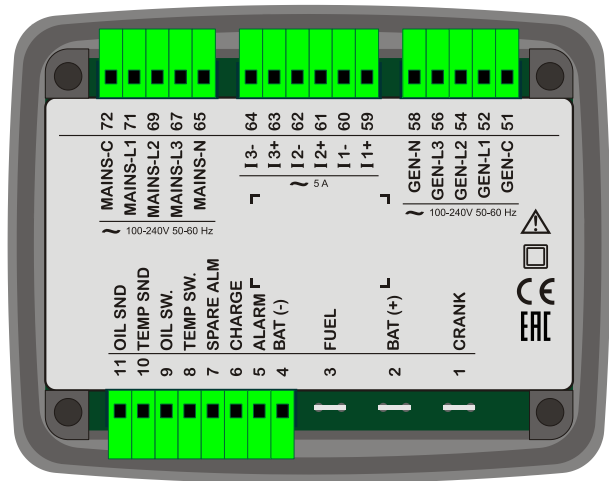
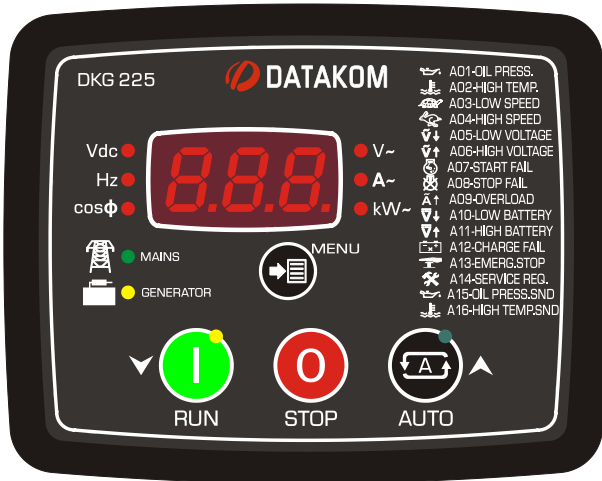

Mount the unit on a flat, vertical surface. Before mounting, remove the mounting brackets and connectors from the unit, then pass the unit through the mounting opening.

Place and tighten mounting brackets.

**The unit is designed for panel mounting. The user should not be able to access parts of the unit other than the front panel.**



The module will come with one of below bracket types:



Screw type bracket



Spring type bracket



Screw type bracket installation



Spring type bracket installation

 **Do not tighten too much, this may break the unit.**

## 2.2. SEALING, GASKET

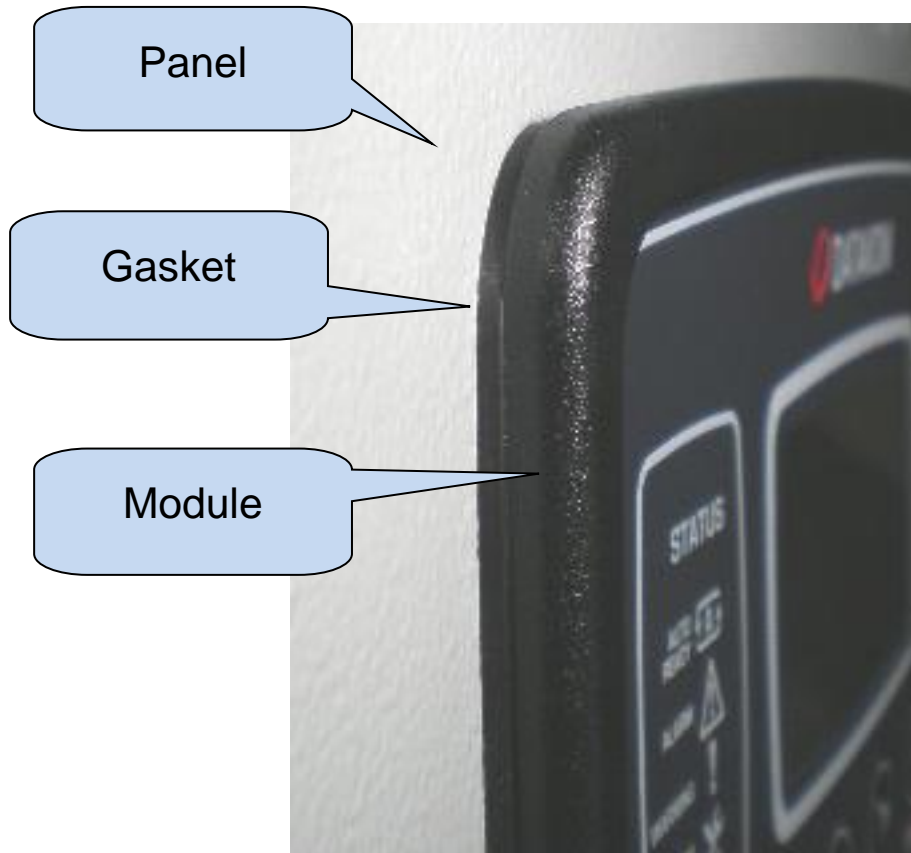

The rubber gasket provides a watertight means of mounting the module to the gasket panel. Together with the gasket, IEC 60529-IP65 protection can be reached from the front panel. A short definition of IP protection levels is given below.

### 1st Digit

- 0 Not protected
- 1 Protected against solid foreign objects of 50 mm diameter and greater
- 2 Protected against solid foreign objects of 12,5 mm diameter and greater
- 3 Protected against solid foreign objects of 2,5 mm diameter and greater
- 4 Protected against solid foreign objects of 1,0 mm diameter and greater
- 5 Protected from the amount of dust that would interfere with normal operation

### 2nd Digit

- 0 Not protected
- 1 Protected against vertically falling water drops
- 2 Protected against vertically falling water drops when enclosure is tilted up to 15 °
- 3 Protected against water sprayed at an angle up to 60 ° on either side of the vertical
- 4 Protected against water splashed against the component from any direction
- 6 Protected against water projected in powerful jets from any direction
- 7 Protected against temporary immersion in water
- 8 Protected against continuous immersion in water, or as specified by the user

## 2.3. ELECTRICAL INSTALLATION



Do not install the unit close to high electromagnetic noise emitting devices like contactors, high current busbars, switchmode power supplies and the like.

Although the unit is protected against electromagnetic disturbance, excessive disturbance can affect the operation, measurement precision and data communication quality.

- **ALWAYS** remove plug connectors when inserting wires with a screwdriver.
- Fuses must be connected to phase voltage inputs, in close proximity of the unit.
- Fuses must be of fast type (FF) with a maximum rating of 6A.
- Use cables of appropriate temperature range.
- Use adequate cable section, at least 0.75mm<sup>2</sup> (AWG18).
- Follow national rules for electrical installation.
- Current transformers must have 5A output.
- The current transformer cable length should not exceed 1.5 meters. If longer cable is used, increase the cable section proportionally.



Current Transformers must be used for current measurement.  
No direct connection allowed.



For the correct operation, engine body must be grounded.  
Otherwise faulty voltage and frequency measurements may occur.

### 3. TERMINAL DESCRIPTIONS

#### 3.1. BATTERY VOLTAGE INPUT / OUTPUT

Battery terminals are both internal battery charger outputs and battery supply inputs.

When AC mains supply is available, the unit charges the battery. When mains voltages fail, the unit continues operation through the engine battery.

<b>Charger output voltage:</b>	13.7VDC
<b>Charger output current</b>	1.0 ADC
<b>Operating voltage range:</b>	8 - 16VDC
<b>Cranking dropouts:</b>	Survives 0VDC during 100ms. The voltage before surge should be 9VDC minimum
<b>Max. Operating current:</b>	200mA @ 12VDC. (All features active, outputs open)
<b>Typical operating current:</b>	100mA @ 12VDC. (All features passive, digital outputs open)
<b>Measurement range:</b>	0 - 36VDC
<b>Display resolution:</b>	0.1VDC
<b>Accuracy:</b>	1.0% + 1 digit @ 12VDC



**Be sure that battery connection is not reversed. Reverse connection will damage the unit.**

#### 3.2. AC VOLTAGE INPUTS

<b>Measurement method:</b>	True RMS
<b>Input voltage range:</b>	14 to 300 VAC (phase-neutral)
<b>Min voltage for frequency detect:</b>	14 VAC (Ph-N)
<b>Measurement range:</b>	0 to 330VAC ph-N (0 to 570VAC ph-ph)
<b>Common mode offset:</b>	Max 100V between neutral and battery negative
<b>Input impedance:</b>	4.5M-ohms
<b>Display resolution:</b>	1VDC
<b>Accuracy:</b>	1.0% + 1 digit @ 230VAC ph-N ( $\pm 3$ VAC ph-N) 1.0% + 1 digit @ 400VAC ph-ph ( $\pm 5$ VAC ph-ph)
<b>Frequency range:</b>	DC to 100 Hz
<b>Frequency display resolution:</b>	0.1 Hz
<b>Frequency accuracy:</b>	0.2% + 1 digit ( $\pm 0.2$ Hz @ 50Hz)

### 3.3. AC CURRENT INPUTS

<b>Measurement method:</b>	True RMS
<b>CT secondary rating:</b>	5A
<b>Measurement range:</b>	5/5 to 500/5A minimum
<b>Input impedance:</b>	15 mili-ohms
<b>Burden:</b>	0.375W
<b>Maximum continuous current:</b>	6A
<b>Measurement range:</b>	0.1 to 7.5A
<b>Common mode offset:</b>	Max 5VAC between BAT- and any CT terminal.
<b>Display resolution:</b>	1A, 0.1A (3 digits)
<b>Accuracy:</b>	1.0% + 1 digit @ 5A ( $\pm 0.6A$ @ 5/50A)

#### SELECTING THE CT RATING AND CABLE SECTION:

The load on a CT should be kept minimum in order to minimize phase shift effect of the current transformer. Phase shift in a CT will cause erroneous power and power factor readings, although amp readings are correct.

Datakom advises CT rating to be selected following this table for the best measurement accuracy.

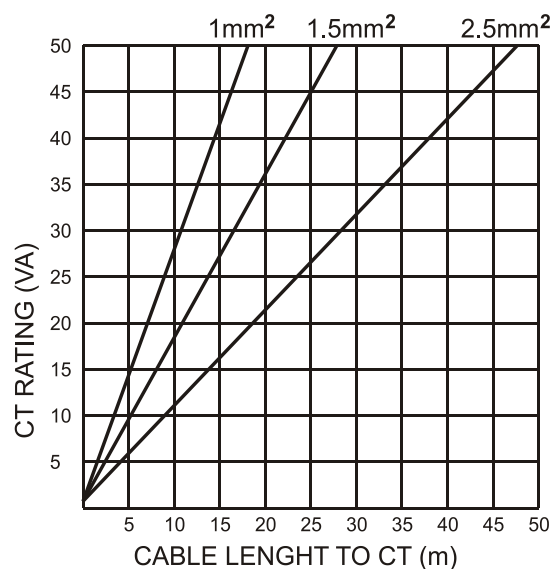

#### SELECTING THE CT ACCURACY CLASS:

The CT accuracy class should be selected in accordance with the required measurement precision. The accuracy class of the Datakom controller is 1.0%. Thus 1.0% class CTs are advised for the best result.



- **Current Transformers must be used for current measurement. No direct connection allowed.**
- **No common terminals or grounding allowed.**

**CONNECTING CTs:**

Be sure of connecting each CT to the related phase input with the correct polarity. Mixing CTs between phases will cause faulty power and pf readings.

Many combinations of incorrect CTs connections are possible, so check both order of CTs and their polarity. Reactive power measurement is affected by incorrect CTs connection in similar way as active power measurement.

**CORRECT CT CONNECTIONS**

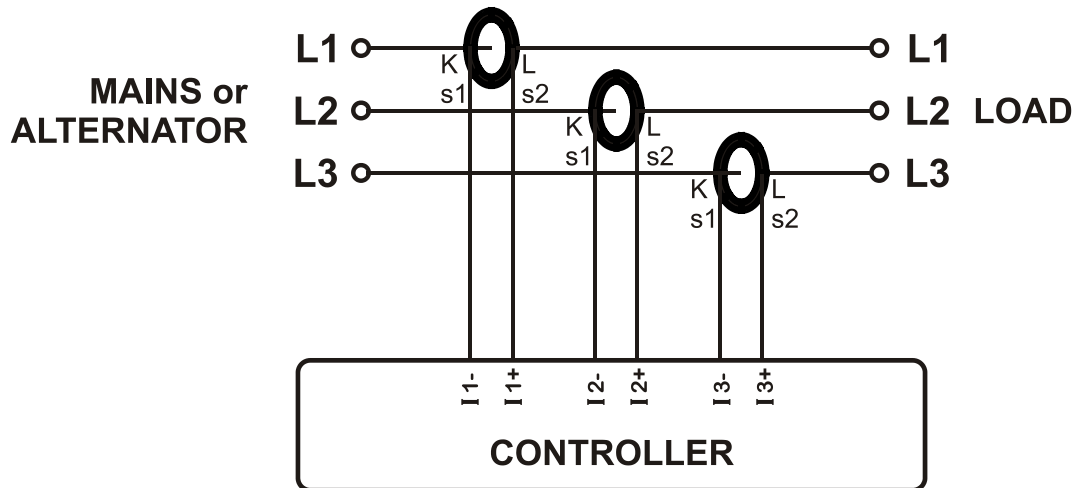

Let's suppose that the genset is loaded with 10 kW on each phase. The load Power Factor (PF) is 1. Measured values are as follows:

	<b>kW</b>	<b>kVAr</b>	<b>kVA</b>	<b>pf</b>
<b>Phase L1</b>	10.0	0.0	10	1.00
<b>Phase L2</b>	10.0	0.0	10	1.00
<b>Phase L3</b>	10.0	0.0	10	1.00
<b>Total</b>	<b>30.0</b>	<b>0.0</b>	<b>30</b>	<b>1.00</b>

**EFFECT OF POLARITY REVERSAL**

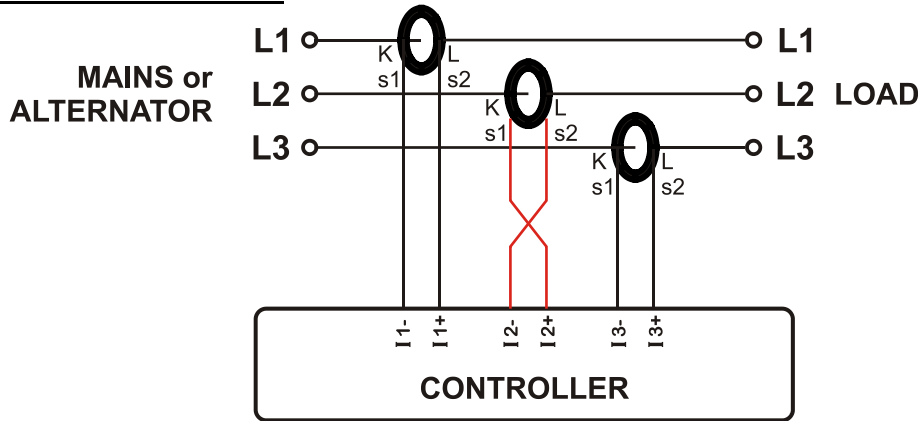

The generator is still loaded with 10 kW On each phase. The load Power Factor (PF) is 1. PF in phase L2 will show -1,00 due to reverse CT polarity. The result is that total generator power displayed by the controller is 10 kW. Measured values are as follows:

	kW	kVAr	kVA	pf
Phase L1	10.0	0.0	10	1.00
Phase L2	-10.0	0.0	10	-1.00
Phase L3	10.0	0.0	10	1.00
<b>Total</b>	<b>10.0</b>	<b>0.0</b>	<b>30</b>	<b>0.33</b>

**EFFECT OF PHASE SWAPPING**

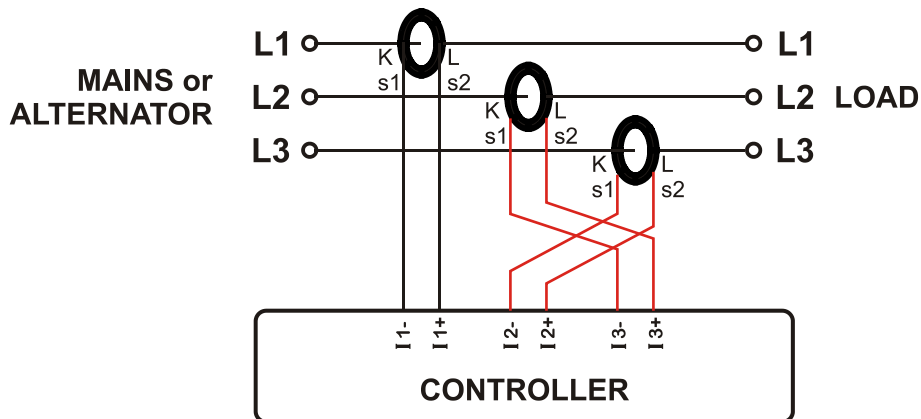

The generator is still loaded with 10 kW on each phase. The load Power Factor (PF) is 1. PF in phases L2 and L3 will show -0,50 due to phase shift between voltages and currents which is caused by CT swapping. The result is that total generator power displayed by controller is 0 kW. Measured values are as follows:

	kW	kVAr	kVA	pf
Phase L1	10.0	0.0	10	1.00
Phase L2	-5.0	8.6	10	-0.50
Phase L3	-5.0	-8.6	10	-0.50
<b>Total</b>	<b>0.0</b>	<b>0.0</b>	<b>30</b>	<b>0.0</b>

### 3.4. DIGITAL INPUTS

<b>Contact type:</b>	Normally open or normally closed (programmable)
<b>Switching:</b>	Battery negative or battery positive (programmable)
<b>Structure:</b>	47 k-ohms resistor to battery positive, 110k-ohms to battery negative.
<b>Measurement:</b>	Analog voltage measurement.
<b>Open circuit voltage:</b>	70% of battery voltage
<b>Low level threshold:</b>	35% of battery voltage
<b>High level threshold:</b>	85% of battery voltage
<b>Maximum input voltage:</b>	+100VDC with respect to battery negative
<b>Minimum input voltage:</b>	-70VDC with respect to battery negative
<b>Noise filtering:</b>	yes

### 3.5. ANALOG SENDER INPUTS

<b>Structure:</b>	667 ohms resistor polarizing to 3.3VDC
<b>Measurement:</b>	Analog resistor measurement.
<b>Open circuit voltage:</b>	+3.3VDC
<b>Short circuit current:</b>	5mA
<b>Measurement range:</b>	0 to 5000 ohms.
<b>Open circuit threshold:</b>	5000 ohms.
<b>Resolution:</b>	1 ohms @ 300 ohms or lower
<b>Accuracy:</b>	2 %+1 ohm ( $\pm 7$ ohms @300 ohms)
<b>Noise filtering:</b>	yes



### 3.6. CHARGE INPUT TERMINAL

The Charge terminal is both an input and output.

When the engine is ready to run, this terminal supplies the excitation current to the charge alternator.

The excitation circuit is equivalent to a 2W lamp.

<b>Structure:</b>	<ul style="list-style-type: none"> <li>• battery voltage output through 82 ohm resistor</li> <li>• voltage measurement input</li> </ul>
<b>Output current:</b>	130mA @12VDC
<b>Charge Fail Warning Threshold:</b>	6VDC
<b>Open circuit voltage:</b>	battery positive
<b>Overvoltage protection:</b>	> 500VDC continuous, with respect to battery negative
<b>Reverse voltage protection:</b>	-30VDC with respect to battery negative

### 3.7. MAINS CONTACTOR OUTPUT

<b>Structure:</b>	Relay output, normally closed contact. One terminal is internally connected to mains phase L1 input.
<b>Max switching current:</b>	16A @250VAC
<b>Max switching voltage:</b>	440VAC
<b>Max switching power:</b>	3000VA

### 3.8. GENERATOR CONTACTOR OUTPUT

<b>Structure:</b>	Relay output, normally open contact. One terminal is internally connected to genset phase L1 input.
<b>Max switching current:</b>	16A @250VAC
<b>Max switching voltage:</b>	440VAC
<b>Max switching power:</b>	4000VA

### 3.9. DIGITAL OUTPUTS

The unit has 3 digital outputs. One of them may be selected as FUEL or STOP. The auxiliary output function may be selected from list.

<b>Structure:</b>	Positive switching relay outputs
<b>Max. Continuous current:</b>	Fuel & crank:40A, Auxiliary:10A
<b>Max. Switching voltage:</b>	16 VDC

**4. CONNECTION DIAGRAM**

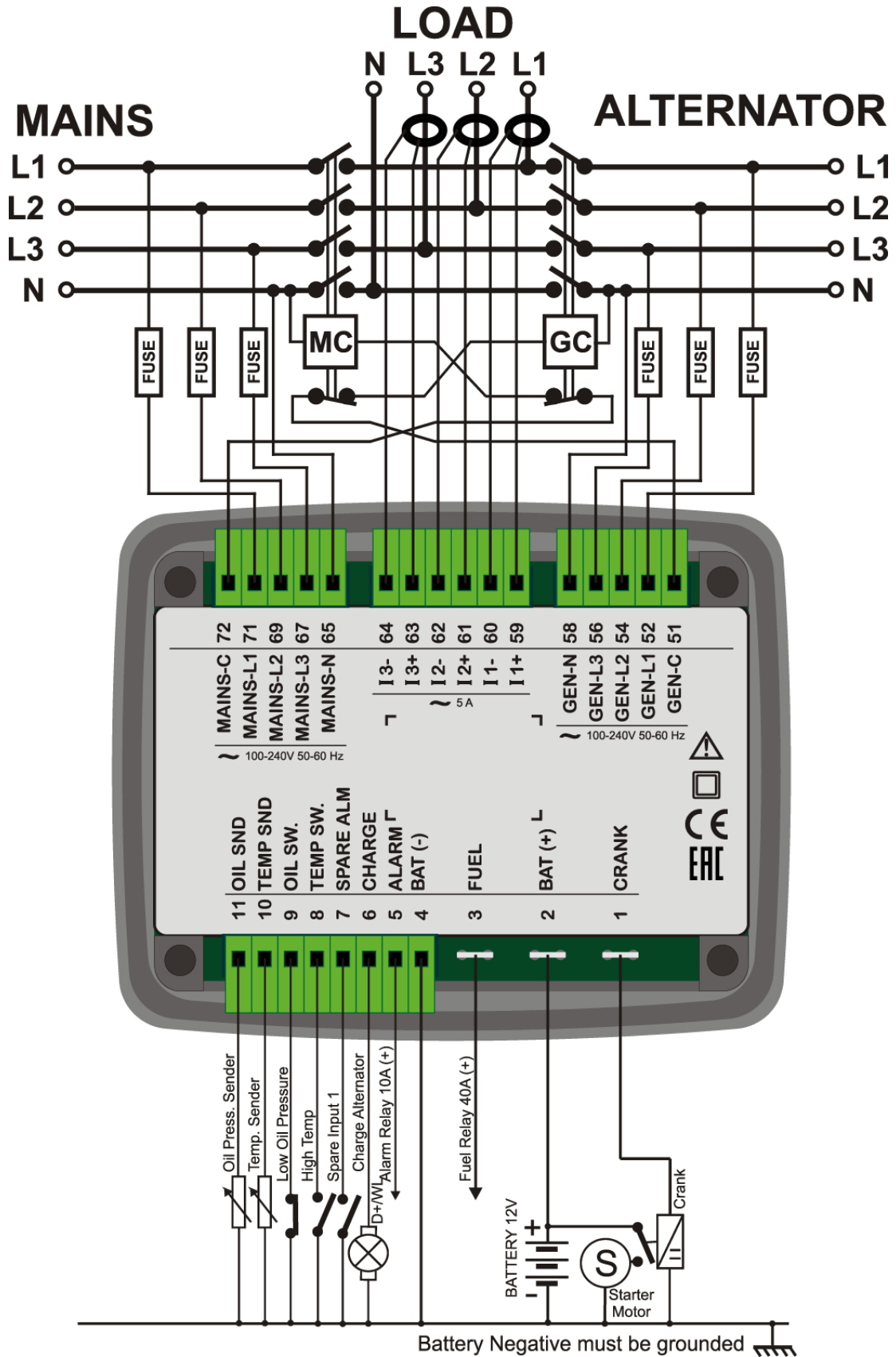

## 5. TERMINAL DESCRIPTION

Term	Function	Technical data	Description
1	CRANK	Relay Output 40A/12V-DC	<b>CRANK</b> output, capable of driving the starter motor directly.
2	BATTERY POSITIVE	+12 V-DC	The positive terminal of the DC Supply.
3	FUEL	Relay Output 40A/12V-DC	<b>FUEL</b> output, capable of driving the FUEL solenoid directly.

Term	Function	Technical data	Description
4	BATTERY NEGATIVE	0 VDC	Power supply negative connection.
5	ALARM RELAY OUTPUT	10A-DC/12V-DC	This relay has programmable function, selectable from a list. Factory set as <b>ALARM</b> output.
6	CHARGE	Input and output	Connect the charge alternator's D+/WL terminal to this terminal. This terminal will supply the excitation current and measure the voltage of the charge alternator.
7	SPARE ALARM INPUT	Digital Inputs, 0-30Vdc	The priority level of this input is adjustable.
8	HIGH TEMP SWITCH		Connect to the high temperature switch to this terminal.
9	LOW OIL PRESSURE SWITCH		Connect to the low oil pressure switch to this terminal.
10	COOLANT TEMP. SENDER	Resistor measuring inputs, 0-5000 ohms	Connect to the coolant temperature sender. Do not connect the sender to other devices. The input is programmable in order to use to any sender type.
11	OIL PRESSURE SENDER		Connect to the oil pressure sender. Do not connect the sender to other devices. The input is programmable in order to use to any sender type.

Term	Function	Technical data	Description
51	GENERATOR CONTACTOR	Relay output, 16A-AC	This output provides energy to the generator contactor. If the generator phases do not have acceptable voltage or frequency values, the generator contactor will be de-energized. In order to provide extra security, the normally closed contact of the mains contactor should be serially connected to this output.
52	GEN-L1	Generator phase inputs, 0-300V-AC	Connect the generator phases to these inputs. The generator phase voltages upper and lower limits are programmable.
54	GEN-L2		
56	GEN-L3		
58	GENERATOR NEUTRAL	Input, 0-300V-AC	Neutral terminal for the generator phases.

Term	Function	Technical data	Description
59	CURR_1+	Current transformer inputs, 5A-AC	Connect the generator current transformer terminals to these inputs. Do not connect the same current transformer to other instruments otherwise a unit fault will occur. Connect each terminal of the transformer to the unit's related terminal. Do not use common terminals. Do not use grounding. Correct polarity of connection is vital. The rating of the transformers should be identical for each of the 3 phases. The secondary winding rating shall be 5 Amperes. (ex: 200/5 Amps).
60	CURR_1-		
61	CURR_2+		
62	CURR_2-		
63	CURR_3+		
64	CURR_3-		

Term	Function	Technical data	Description
65	MAINS NEUTRAL	Input, 0-300V-AC	Neutral terminal for the mains phases.
67	MAINS-L3	Mains phase inputs, 0-300V-AC	Connect the mains phases to these inputs. The mains voltages upper and lower limits are programmable.
69	MAINS-L2		
71	MAINS-L1		
72	MAINS CONTACTOR	Relay output, 16A-AC	This output provides energy to the mains contactor. If the mains phases do not have acceptable voltages, the mains contactor will be de-energized. In order to provide extra security, the normally closed contact of the generator contactor should be serially connected to this output.

## 6. TECHNICAL SPECIFICATIONS

**Alternator Voltage:** 0-300 V-AC (Phase-Neutral)

**Alternator Frequency:** 0-100 Hz.

**Mains Voltage:** 0-300 V-AC (Phase-Neutral)

**Mains Frequency:** 0-100 Hz.

**Topology:** 1 or 3 phases with neutral

**Cranking Dropouts:** survives 0V for 100ms.

**Fuel and Crank Relay Outputs:** 40 A / 12V-DC

**Alarm Relay Output:** 10A / 12 V-DC

**MC and GC Relay Outputs:** 16A / 250 V-AC

**Charge Excitation:** min 2 W.

**Battery Charge Current:** min 1A / 13.7V-DC (195-300V-AC)

**Current Inputs:** CT inputs xxx/5A (opt xxx/0.1A)

**Analog Input Range:** 0-5000 ohms

**Digital Inputs:** 0 to 36V-DC

**Operating temp.:** -40°C (-40°F) to 70°C (158°F).

**Storage temp.:** -55°C (-67°F) to 80°C (176°F).

**Maximum humidity:** 95% non-condensing.

**Dimensions:** 133x 107 x 46 mm (WxHxD)

**Panel Cutout:** 117 x 87mm minimum.

**Weight:** 200 g (approx..)

**Enclosure:** Flame retardant, high temp ABS/PC (UL94-V0)

**IP Protection:** IP65 (front with gasket), IP30 (rear)

**EU Directives Conformity**

-2006/95/EC (low voltage)

-2004/108/EC (electro-magnetic compatibility)

**Reference standards for EU Conformity:**

-EN 61010 (safety)

-EN 61326 (EMC)

## 7. DESCRIPTION OF CONTROLS

### 7.1. FRONT PANEL FUNCTIONALITY

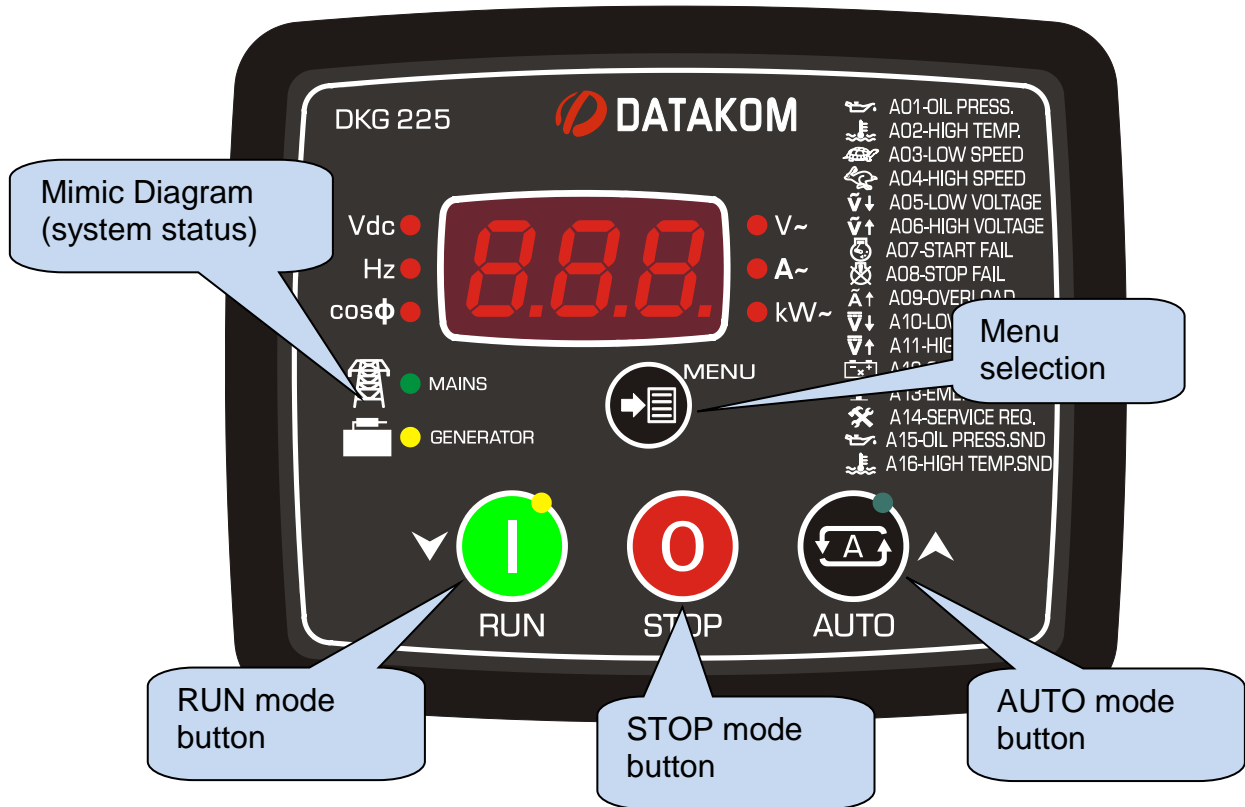

### 7.2. PUSHBUTTON FUNCTIONS

BUTTON	FUNCTION
	Selects RUN mode. The genset runs off-load.
	Selects AUTO mode. The genset runs when necessary and takes the load.
	Selects OFF mode. The genset stops. If held pressed for 10 seconds, resets service counters.
	Selects next display parameter. If held pressed, select the LAMP TEST then PROGRAMMING functions.
	When held pressed for 5 seconds, enters a special PROGRAMMING mode where high level parameters may also be adjusted.

### 7.3. DISPLAY SCREEN ORGANIZATION

The unit measures a large number of electrical and engine parameters. The display of the parameters is organized as a list which can be scanned by pressing the MENU button.

Each depression of the  button will cause the display to switch to the next parameter. After the last parameter the display will switch to the first parameter.

Parameter list:

**Mains phase-neutral voltages:** L1, L2, L3

**Mains phase-phase voltages:** L12, L23, L31

**Genset phase-neutral voltages:** L1, L2, L3

**Genset phase-phase voltages:** L12, L23, L310

**Load currents:** L1, L2, L3

**Total active power**

**Total cosØ**

**Genset frequency**

**Battery voltage**

**Oil pressure**

**Coolant temperature**

**Engine run hours**

**Engine run hours to service**

**Time to service**

**Firmware version**

### 7.4. MEASURED PARAMETERS

The unit performs a detailed set of AC measurements.

**The list of measured AC parameters is below:**

Mains voltage phase L1 to neutral

Mains voltage phase L2 to neutral

Mains voltage phase L3 to neutral

Mains voltage phase L1-L2

Mains voltage phase L2-L3

Mains voltage phase L3-L1

Mains frequency

Mains current phase L1

Mains current phase L2

Mains current phase L3

Mains total kW

Mains total pf

Gen voltage phase L1 to neutral

Gen voltage phase L2 to neutral

Gen voltage phase L3 to neutral

Gen voltage phase L1-L2

Gen voltage phase L2-L3

Gen voltage phase L3-L1

Gen frequency

Gen current phase L1

Gen current phase L2

Gen current phase L3

Gen average current

Gen total kW

Gen total pf

Battery voltage

Oil pressure (bar, kPa)

Coolant temperature

**7.5. LED INDICATORS**

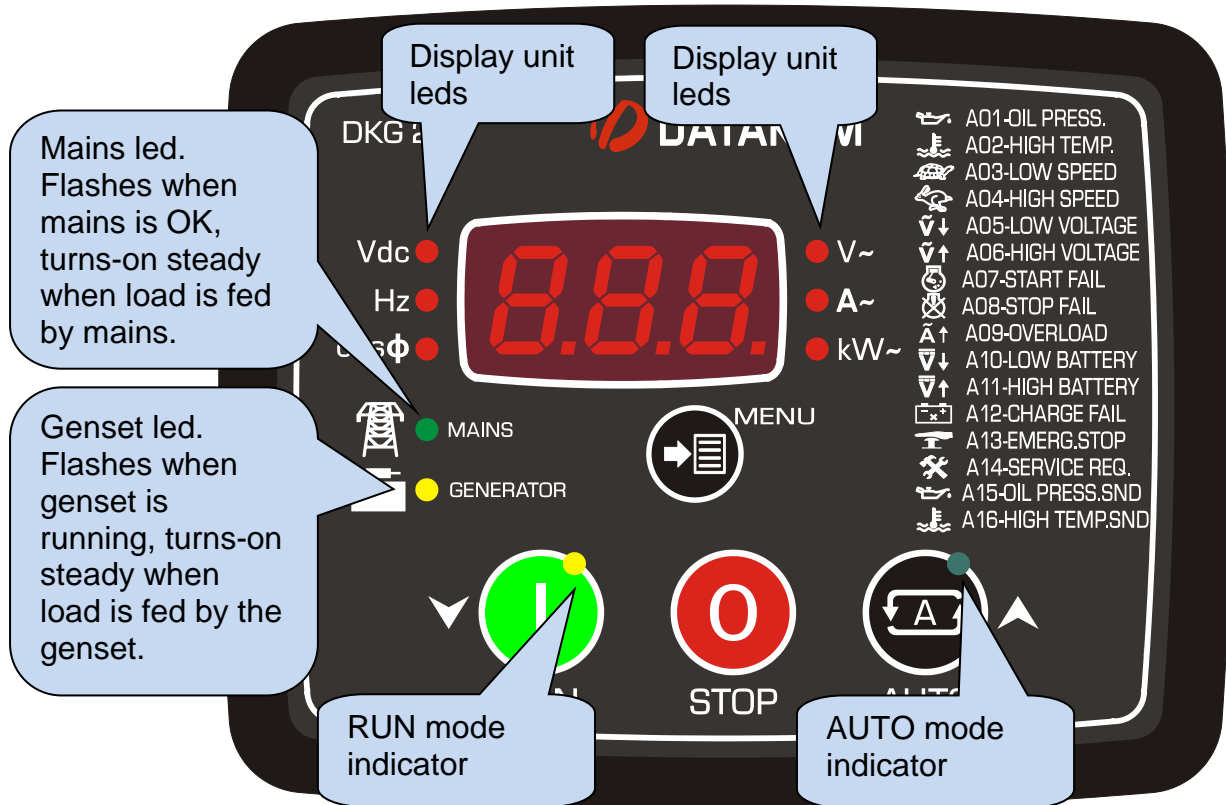

**MODE LEDS:** Turns on when related operating mode is selected.

**MAINS AND GENSET LEDS:**

**MAINS:** Flashes when all mains phase voltages and the mains frequency are within limits. Turns on when the load is fed by the mains.

**GENSET:** Flashes when all genset phase voltages and the genset frequency are within limits. Turns on when the load is fed by the genset.



**If a REMOTE START input is defined, the MAINS led will reflect the status of the REMOTE START signal. The led is also affected by MAINS SIMULATION and FORCE TO START signals.**



## 8. OPERATION OF THE UNIT

### 8.1. QUICK START GUIDE

**STOPPING THE GENSET:** Press STOP  button

**STARTING THE GENSET:** Press RUN  button

**AUTOMATIC OPERATION:** Press AUTO  button.



**Mode can be changed anytime without negative effect. Changing the operation mode while the genset is running will result into a behavior suitable for the new operating mode.**

### 8.2. STOP MODE

The STOP mode is entered by pressing the  button.

In this mode, the genset will be in a rest state.

When STOP mode is selected, if the genset is running under load, then it will be immediately unloaded. The engine will continue to run during **Cooldown Timer** and will stop afterwards.

If the STOP button is pressed again, then the engine will immediately stop.

If the engine fails to stop after the expiration of **Stop Timer** then a **Fail to Stop** warning will occur.

In this mode, the mains contactor will be energized only if mains phase voltages and frequency are within the programmed limits. If enabled, the mains phase order is also checked.

### 8.3. MANUAL RUN MODE

The RUN mode is entered by pressing the  button.

When the RUN mode is selected, the engine will be started regardless of the mains availability.



**If Emergency Backup mode is enabled and if the mains are off, then the mains contactor will be deactivated and the generator contactor will be activated.**

**When the mains are on again, a reverse changeover to the mains will be performed, but the engine will keep running unless another mode is selected.**

In order to stop the genset please press  button or select another operating mode.

## 8.4. AUTO MODE

The AUTO mode is entered by pressing the  button.

The AUTO mode is used for the automatic transfer between genset and mains. The controller will constantly monitor the mains availability. It will run the engine and transfer the load when a mains failure occurs.

### **The mains availability evaluation sequence is below:**

- If at least one of the mains phase voltages or the mains frequency is outside limits, the mains will be supposed failing. Otherwise mains is available.
- If a Simulate Mains signal is present, then mains are made available
- If a Force to Start signal is present, then mains are unavailable
- If a Remote Start input is defined, then this signal decides of mains availability.

### **When mains are evaluated as “unavailable” then an engine start sequence begins:**

- The unit waits during Engine Start Delay for skipping short mains failures. If the mains is restored before the end of this timer, the genset will not start.
- The unit turns on the fuel and preheat glow plugs (if any) and waits for preheat timer.
- The engine will be cranked for programmed times during crank timer. When the engine fires, the crank relay will be immediately deactivated. See section **Crank Cutting** for more details.
- The engine will run unloaded during engine heating timer.
- If alternator phase voltages, frequency and phase order are correct, the unit will wait for the generator contactor period and the generator contactor will be energized.

### **When mains are evaluated as “available” again then an engine stop sequence begins:**

- The engine will continue to run for the mains waiting period to allow mains voltages to stabilize.
- Then the generator contactor is deactivated and the mains contactor will be energized after mains contactor timer.
- If a cooldown period is given, the generator will continue to run during the cooldown period.
- Before the end of cooldown, the unit will reduce the engine speed to idle speed.
- At the end of cooldown, the fuel solenoid will be de-energized, the stop solenoid will be energized for Stop Solenoid timer and the diesel will stop.
- The unit will be ready for the next mains failure.

## 9. PROTECTIONS AND ALARMS

The unit provides 3 different protection levels, being warnings, loaddumps and shutdown alarms.

- 1- **SHUTDOWN ALARMS:** These are the most important fault conditions and cause:
  - The display to show the alarm code,
  - The genset contactor to be released immediately,
  - The engine to be stopped immediately,
  - The **Alarm** digital output to operate.
- 2- **LOADDUMPS:** These fault conditions come from electrical trips and cause:
  - The display to show the alarm code,
  - The genset contactor to be released immediately,
  - The engine to be stopped after Cooldown period,
  - The **Alarm** digital output to operate.
- 3- **WARNINGS:** These conditions cause:
  - The alarm code flashed on the display,
  - The **Alarm** digital output to operate.



If a fault condition occurs, the alarm code is displayed.

### Alarms operate in a first occurring basis:

- If a shutdown alarm is present, following shutdown alarms, loaddumps and warnings will not be accepted,
- If a loaddump is present, following loaddumps and warnings will not be accepted,
- If a warning is present, following warnings will not be accepted.



If multiple alarms are present, they can be scanned by pressing the MENU button.

Alarms may be of **LATCHING** type following programming.

For latching alarms, even if the alarm condition is removed, the alarms will stay on and disable the operation of the genset.



Existing alarms may be canceled by pressing one of the operating mode buttons:



Most of the alarms have programmable trip levels. See the programming chapter for adjustable alarm limits.

## 9.1. SERVICE REQUEST ALARM

The SERVICE REQUEST led is designed to help the periodic maintenance of the genset to be made consistently.

The periodic maintenance is basically carried out after a given engine hours (for example 200 hours), but even if this amount of engine hours is not fulfilled, it is performed after a given time limit (for example 12 months).

The service counter set has both programmable engine hours and maintenance time limit. If any of the programmed values is zero, this means that the parameter will not be used. For example a maintenance period of 0 months indicates that the unit will request maintenance only based on engine hours, there will be no time limit. If the engine hours is also selected as 0 hours this will mean that this service counter set is not operative.

When the engine hours **OR** the time limit is over, the unit will give **A14** (SERVICE REQUEST) warning.



**To turn off the SERVICE REQUEST led, and reset the service period, press the  key for 10 seconds. When “Srv” is displayed, service timers are reset and the service request alarm is erased.**

The remaining engine hours and the remaining time limits are kept stored in a non-volatile memory and are not affected from power supply failures.

The time and engine hours to service are displayed in the display menu.

## 9.2. ALARMS

**A01-LOW OIL PRESSURE SWITCH:** Set if a signal is detected at the Low Oil Pressure Switch. This fault will be monitored with **Holdoff Timer** delay after the engine is running.

**A02-HIGH TEMPERATURE SWITCH:** Set if a signal is detected at the High Temperature Switch input.

**A03-LOW SPEED (alarm/warning):** Set if the generator frequency is below programmed limits. This fault will be monitored with **Holdoff Timer** delay after the engine is running. Limits for warning and alarm are separately programmable.

**A04-HIGH SPEED (alarm/warning):** Set if the generator frequency is above programmed limits. This fault will be monitored with **Holdoff Timer** delay after the engine is running. Limits for warning and alarm are separately programmable. Another high shutdown limit which is 12% above the high limit is always monitored and stops the engine immediately.

**A05-GENSET LOW VOLTAGE:** Set if any of the generator phase voltages goes below programmed limit for **Overload Timer**. This fault will be monitored with **holdoff timer** delay after the engine is running.

**A06-GENSET HIGH VOLTAGE:** Set if any of the generator phase voltages goes above programmed limits for **Overload Timer**. This fault will be monitored with **holdoff timer** delay after the engine is running.

**A07-START FAIL (alarm):** Set if the engine is not running after programmed number of start attempts.

**A08-STOP FAIL (warning):** Set if the engine has not stopped before the expiration of the **Stop Timer**.

**A09-OVERLOAD (load dump):** Set if at least one of the genset phase currents goes over the **Overcurrent Limit** for **Overload Timer**. Set also if the genset total active power (kW) supplied to the load goes over the **Excess Power** limit for **Overload Timer**. If currents and power go below the limit before expiration of the timer then no alarm will be set.

**A10-LOW BATTERY VOLTAGE (warning):** Set if the battery voltage goes below the programmed limit. During engine cranking this fault is not monitored.

**A11-HIGH BATTERY VOLTAGE:** Set if the battery voltage goes above programmed limits. Both warning and alarm levels for high battery voltage are programmable.

**A12-CHARGE:** Set if a charge alternator failure (or broken belt) occurs. This fault condition may result to a **warning** or **alarm** following programming.

**A13-EMERGENCY STOP (alarm/loaddump/warning):** Set if a signal is detected at the emergency stop input. The priority level of the alarm caused by this input is programmable.

**A14-SERVICE REQUEST (warning):** Set if the programmed engine hours or period is exceeded.

**A15-LOW OIL PRESSURE SENDER:** Set if the oil pressure value measured from the sender is below the programmed limit. Warning and alarm limits are separately programmable for the oil pressure sender input. This fault will be monitored with **Holdoff Timer** delay after the engine is running.

**A16-HIGH TEMPERATURE SENDER:** Set if the coolant temperature value measured from the sender is above the programmed limit. Warning and alarm limits are separately programmable for the temperature sender input.

## 10. PROGRAMMING

The program mode is used to program timers, operational limits and the configuration of the unit.

To **enter the program mode**, hold pressed the **MENU** button for 10 seconds.

When the program mode is entered, if the MENU button is pressed, the display will indicate the program parameter number. When the button is released, the display will show the parameter value.

The program mode will not affect the operation of the unit. Thus programs may be modified anytime, even while the genset is running.

Navigation between program parameters is performed via the **MENU** button. Holding the button pressed will cause the program parameter number to increase faster.

Parameter value may be increased and decreased with RUN (▼) and AUTO (▲) buttons. If these keys are held pressed, the program value will be increased/decreased faster.

When a program parameter is modified, it is automatically saved in memory.

If **MENU** button is pressed, next parameter will be displayed.

Program parameters are kept in a non-volatile memory and are not affected from power failures.

To **exit the program mode** press STOP key. If no button is pressed during 1 minute the program mode will be cancelled automatically.

Program parameters are organized in 2 groups as low and high levels. Entering the program mode by pressing the **MENU** button will allow access to only low level parameters.

In order to access all parameters please hold **STOP** and **MENU** buttons pressed together for 10 seconds.

PGM	Parameter Name	Unit	Std.	Description
P_00	Current Transformer Ratio	A	50	This is the rated value of current transformers. All transformers must have the same rating. The secondary of the transformer will be 5 Amps.
P_01	Fuel output type	-	0	<b>0:</b> activate to start <b>1:</b> activate to stop
P_02	Oil switch type	-	0	<b>0:</b> oil pressure switch <b>1:</b> oil level switch
P_03	Single phase operation	-	0	<b>0:</b> tri phased <b>1:</b> single phased
P_04	Overcurrent limit	A	0	If the current goes above this limit, during the period defined in <b>Overload Timeout</b> then a <b>Overcurrent Load Dump</b> alarm will be generated. If this parameter is 0 then Overcurrent check is disabled.
P_05	Excess power limit	kW	0	If the active power goes above this limit, during the period defined in <b>Overload Timeout</b> then an <b>Excess Power Load Dump</b> alarm will be generated. If this parameter is 0 then Excess Power check is disabled.
P_06	Overcurrent/ Excess Power / Frequency / Voltage delay timer	sec	5	This is the period between <b>OVERCURRENT</b> or <b>EXCESS POWER</b> or <b>VOLTAGE</b> or <b>FREQUENCY</b> limits are exceeded and the related alarm occurs.
P_07	Preheat timer	Sec	1	This is the time after the fuel solenoid is energized and before the genset is started. During this period the <b>PREHEAT</b> relay function is active.
P_08	Choke timer	Sec	5	This is the control delay of <b>CHOKE</b> output. The choke output is activated together with the crank output. It is released after this delay or when engine runs, whichever occurs first.
P_09	Engine heating timer	Sec	4	This is the period used for engine heating before genset takes the load.
P_10	Stop timer	Sec	10	This is the maximum time duration for the engine to stop. During this period the <b>STOP</b> relay function is active. If the genset has not stopped after this period, a <b>FAIL TO STOP</b> warning occurs.
P_11	Mains waiting timer	Min	0.5	This is the time between the mains voltages entered within the limits and the generator contactor is deactivated.
P_12	Cooldown timer	min	1.0	This is the period that the generator runs for cooling purpose after the load is transferred to mains.
P_13	Mains voltage low limit	V	170	If one of the mains phases goes under this limit, it means that the mains are off and it starts the transfer to the genset in <b>AUTO</b> mode.
P_14	Mains voltage high limit	V	270	If one of the mains phases goes over this limit, it means that the mains are off and it starts the transfer to the genset in <b>AUTO</b> mode.



Following parameters are in the “high priority” group.

PGM	Parameter Definition	Unit	Fact.Set	Description
P_15	Genset Low Voltage Shutdown Limit	V	170	If one of the generator phase voltages goes under this limit when feeding the load, this will generate a <b>GENSET LOW VOLTAGE</b> shutdown alarm and the engine will stop.
P_16	Genset Low Voltage Warning Limit	V	180	If one of the generator phase voltages goes under this limit when feeding the load, this will generate a <b>GENSET LOW VOLTAGE</b> warning.
P_17	Genset High Voltage Warning Limit	V	260	If one of the generator phase voltages goes above this limit when feeding the load, this will generate a <b>GENSET HIGH VOLTAGE</b> warning.
P_18	Genset High Voltage Shutdown Limit	V	270	If one of the generator phase voltages goes over this limit when feeding the load, this will generate a <b>GENSET HIGH VOLTAGE</b> alarm and the engine will stop.
P_19	Low Frequency Shutdown	Hz	30	If the genset frequency goes under this limit, a <b>GENSET LOW SPEED</b> alarm is generated and the engine stops.
P_20	Low Frequency Warning	Hz	35	If the genset frequency goes under this limit, a <b>GENSET LOW SPEED</b> warning is generated.
P_21	High Frequency Warning	Hz	54	If the genset frequency goes over this limit, a <b>GENSET HIGH SPEED</b> warning is generated.
P_22	High Frequency Shutdown	Hz	55	If the genset frequency goes over this limit, a <b>GENSET HIGH SPEED</b> alarm is generated and the engine stops.
P_23	Low Battery Voltage Warning	V	9.0	If the battery voltage falls below this limit, this will generate a <b>LOW BATTERY</b> warning.
P_24	High Battery Voltage Warning	V	15.0	If the battery voltage goes over this limit, this will generate a <b>HIGH BATTERY</b> warning.
P_25	High Battery Voltage Shutdown	V	16.0	If the battery voltage goes over this limit, this will generate a <b>HIGH BATTERY</b> shutdown alarm and the engine will stop.
P_26	Hysteresis Voltage	V	8	This parameter provides the mains and genset voltage limits with a hysteresis feature in order to prevent faulty decisions. For example, when the mains are present, the mains voltage low limit will be used as the programmed low limit. When the mains fail, the low limit will be incremented by this value. It is advised to set this value to 8 volts.
P_27	Fault Holdoff Timer	sec	12	This parameter defines the delay after the engine runs and before the fault monitoring is enabled.
P_28	Engine Start Delay	sec	0	This is the time between the mains fails and the fuel solenoid turns on before starting the genset. It prevents unwanted genset operation in battery backed-up loads.
P_29	Gas Solenoid Delay	sec	5	The gas solenoid of the gas engine will be opened after this delay during cranking.
P_30	Crank Timer	sec	10	This is the maximum start period. Starting will be automatically cancelled if the genset fires before the timer.
P_31	Wait Between Starts	sec	10	This is the waiting period between two start attempts.



PGM	Parameter Definition	Unit	Fact.Set	Description
P_32	Genset Contactor Timer	sec	1	This is the period after the mains contactor has been deactivated and before the generator contactor has been activated.
P_33	Mains Contactor Timer	sec	1	This is the period after the generator contactor has been deactivated and before the mains contactor has been activated.
P_34	Number of Starts	-	3	This is the maximum number of start attempts.
P_35	Alarm Relay Timer	sec	60	This is the period during which the ALARM relay is active. If the period is set to 0, this will mean that the period is unlimited.
P_36	Intermittent Alarm Relay	-	0	0: continuous 1: intermittent (turns on and off every second)
P_37	Service Engine Hours	hour	50	The SERVICE REQUEST led indicator will turn on after this quantity of engine hours from the last service. If the period is set to '0' no SERVICE REQUEST will be generated depending on engine hours.
P_38	Service Period	month	6	The SERVICE REQUEST led indicator will turn on after this amount of time from the last service. If the period is set to '0' no SERVICE REQUEST will be indicated depending on time.
P_39	Crank Cut Frequency	Hz	10.0	When the genset frequency reaches this limit, the engine is supposed running and the crank output will release.
P_40	Crank Stop with Oil Pressure	-	0	0: no crank stop with oil pressure 1: cranking is stopped when oil pressure switch is open or the oil pressure measured is above shutdown limit.
P_41	Crank Stop with Charge	-	0	0: no crank stop with charge input 1: cranking is stopped when the charge alternator voltage is established.
P_42	Charge Alternator Shutdown	-	0	0: The charge input generates CHARGE FAIL warning, and does not stop the engine. 1: The charge input generates CHARGE FAIL alarm, and stops the engine.
P_43	Line-to-Line Voltages	-	0	0: Display Line to Neutral voltages as default 1: Display Line to Line voltages as default
P_44	Emergency Backup Operation	-	0	0: In TEST mode, the load will not be transferred to the genset even if the mains fail. 1: In TEST mode, the load will be transferred to the genset if the mains fail.
P_45	Remote Start Enable	-	0	0: no Remote Start signal 1: SPARE input is Remote Start signal
P_46	Simulate Mains Enable	-	0	0: no Simulate Mains signal 1: SPARE input is Simulate Mains signal
P_47	Delayed Simulate Mains	-	0	0: The SPARE input has normal function 1: The SPARE input has delayed simulate mains function. See chapter 12.3 for more info.
P_48	Flashing Relay Timer Engine running timer	hours	0	<b>Delayed Simulate Mains Operation:</b> max genset running time after Simulate Mains signal disappears. <b>Dual Genset Systems:</b> flashing relay ON state duration timer.

---

PGM	Parameter Definition	Unit	Fact.Set	Description
P_49	Low Oil Pressure Warning	bar	1.4	If the oil pressure measured from the analog input falls below this limit, this will generate a <b>LOW OIL PRESSURE SENDER</b> warning.
P_50	Low Oil Pressure Shutdown	bar	1.0	If the oil pressure measured from the analog input falls below this limit, this will generate a <b>LOW OIL PRESSURE SENDER</b> alarm is generated and the engine stops.
P_51	High Temperature Warning	°C	95	If the coolant temperature measured from the analog input goes over this limit, this will generate a <b>HIGH TEMPERATURE SENDER</b> warning.
P_52	High Temperature Shutdown	°C	98	If the coolant temperature measured from the analog input goes over this limit, this will generate a <b>HIGH TEMPERATURE SENDER</b> alarm and the engine will stop.

### Oil Pressure Sender Characteristics

PGM	Parameter Definition	Unit	Factory Set	Description
P_53	Oil Pressure Sender Ohms -1	ohm	10	Oil Pressure Sender point 1, ohm value
P_54	Oil Pressure Value -1	bar	0.0	Oil Pressure Sender point 1, bar value
P_55	Oil Pressure Sender Ohms -2	ohm	52	Oil Pressure Sender point 2, ohm value
P_56	Oil Pressure Value -2	bar	2.0	Oil Pressure Sender point 2, bar value
P_57	Oil Pressure Sender Ohms -3	ohm	90	Oil Pressure Sender point 3, ohm value
P_58	Oil Pressure Value -3	bar	4.0	Oil Pressure Sender point 3, bar value
P_59	Oil Pressure Sender Ohms -4	ohm	140	Oil Pressure Sender point 4, ohm value
P_60	Oil Pressure Value -4	bar	7.0	Oil Pressure Sender point 4, bar value
P_61	Oil Pressure Sender Ohms -5	ohm	156	Oil Pressure Sender point 5, ohm value
P_62	Oil Pressure Value -5	bar	8.0	Oil Pressure Sender point 5, bar value
P_63	Oil Pressure Sender Ohms -6	ohm	184	Oil Pressure Sender point 6, ohm value
P_64	Oil Pressure Value -6	bar	10.0	Oil Pressure Sender point 6, bar value

### Coolant Temperature Sender Characteristics

PGM	Parameter Definition	Unit	Factory Set	Description
P_65	Temperature Sender Ohms -1	ohm	38	Temperature Sender point 1, ohm value
P_66	Temperature Value -1	°C	100	Temperature Sender point 1, °C value
P_67	Temperature Sender Ohms -2	ohm	51	Temperature Sender point 2, ohm value
P_68	Temperature Value -2	°C	90	Temperature Sender point 2, °C value
P_69	Temperature Sender Ohms -3	ohm	134	Temperature Sender point 3, ohm value
P_70	Temperature Value -3	°C	60	Temperature Sender point 3, °C value
P_71	Temperature Sender Ohms -4	ohm	322	Temperature Sender point 4, ohm value
P_72	Temperature Value -4	°C	39	Temperature Sender point 4, °C value
P_73	Temperature Sender Ohms -5	ohm	650	Temperature Sender point 5, ohm value
P_74	Temperature Value -5	°C	20	Temperature Sender point 5, °C value
P_75	Temperature Sender Ohms -6	ohm	978	Temperature Sender point 6, ohm value
P_76	Temperature Value -6	°C	14	Temperature Sender point 6, °C value

### Spare Input Input Configuration

PGM	Parameter Definition	Unit	Fac.Set	Description
P_77	Action		0	0: Shutdown (the engine stops immediately) 1: Load Dump (the engine stops after cooldown) 2: Warning (the horn relay operates) 3: No operation
P_78	Sampling		0	0: Always 1: After holdoff timer 2: When mains present
P_79	Latching		0	0: Non latching 1: Latching
P_80	Contact type		0	0: Normally open 1: Normally closed
P_81	Switching		0	0: Battery negative 1: Battery positive
P_82	Response delay		0	0: No delay 1: Delayed (4sec)

The parameters below define the function of the auxiliary relay output. The relay function is selected from below list.

### Program Group: Relay Definitions

PGM	Parameter Definition	Unit	Fac.Set	Description
P_83	Relay 01 Definition		3	RELAY-1 function selected from list

00	Fuel				80	-
01	Alarm				81	-
02	Crank				82	-
03	Stop				83	-
04	Gen. Contactor				84	-
05	Mains Contactor				85	-
06	Choke				86	Spare warning
07	Preheat				87	-
08	Shutdown alarm				88	Oil sender warning
09	Shutdown or load_dump alarm				89	Temp sender warn.
10	Shutdown or load_dump or warning				90	Low speed warning
11	Automatic ready				91	High speed warning
12	-				92	-
13	-				93	-
14	Load_dump alarm				94	Fail to stop warning
15	Fuel Main winding				95	-
16	Mains Fail				96	Service request warning
17	-				97	-
18	-				98	Low battery warning
19	-				99	High battery warning
20	-				100	Charge fail warning
21	Flashing Relay				101	-
22	-				102	-
23	-				103	-
24	-				104	Gen Low voltge warn.
25	-				105	Gen High voltge warn.
26	Idle Speed				106	-
27	-				107	-
28	-				108	-
29	-				109	-
30	-				110	-
31	-				111	-
32	Oil switch alarm				112	-
33	Temp switch alarm				113	-
34	-				114	-
35	-				115	-
36	-				116	-
37	-				117	-
38	Spare Alarm				118	-
39	-				119	-
40	Oil sender alarm					
41	Temp sender alarm					
42	Low speed alarm					
43	High speed alarm					
44	Low voltage alarm					
45	High voltagealarm					
46	Fail to start alarm					
47	-					
48	-					
49	-					
50	-					
51	High battery voltage alarm					
52	Charge fail alarm					
53	-					
54	-					
55	-					
56	-					
57	-					
58	-					
59	-					
60	-					
61	-					
62	Spare load_dump					
63	-					
64	-					
65	-					
66	-					
67	-					
68	-					
69	-					
70	-					
71	-					
72	Overcurrent load_dump					
73	Excess power Idd					
74	-					
75	-					
76	-					
77	-					
78	-					
79	-					

## 11. CRANK CUTTING

In order to insure fast and reliable crank cutting, the unit uses various resources for engine running condition detection.

Cranking is stopped when **at least one** of below conditions is met:

**- Crank timer expired:**

The crank timer is adjusted through programming menu. The maximum allowed timer is 15 seconds.

**- Genset AC voltage over threshold:**

If the genset phase L1 AC voltage reaches **Crank Cut Voltage**, then cranking is immediately stopped.

**- Genset frequency over threshold:**

If the genset phase L1 frequency reaches **Crank Cut Frequency**, then cranking is immediately stopped.

**- Charge alternator voltage over threshold**

Following setting is necessary: **Crank Stop with Charge = 1**

If the charge alternator voltage reaches 6 volts, then cranking is immediately stopped.

**- Oil pressure above threshold**

Following setting is necessary: **Crank Cut with Oil Pressure = 1**

The crank cutting with oil pressure offers a fixed delay of 2 seconds.

Both low oil pressure switch and oil pressure sender readings may be used for crank cutting. The oil pressure switch is always used.

When oil pressure is above the Low Oil Pressure Shutdown Limit, cranking is stopped after adjustable timer delay.

## 12. SOFTWARE FEATURES

### 12.1 Remote Start Operation

The unit offers the possibility of **REMOTE START** mode of operation. The **SPARE** input may be assigned as **Remote Start Input** using the program parameter **P\_45**.

The REMOTE START signal may be a NO or NC contact, switching to either battery positive or battery negative. These selections are made using programming menu.

It is also necessary to set the **ACTION** program parameter of the **SPARE** input to **3** in order to prevent any alarm from this input using the program parameter **P\_77**.

In this mode the mains phases are not monitored. If the REMOTE START signal is present then the mains will be supposed to fail, inversely if the REMOTE START signal is absent, then mains voltages will be supposed to be present. The front panels mimic diagram's mains LEDs will reflect the status of the REMOTE START input.

### 12.2 Mains Simulation (Disable Start)

The unit offers an optional **SIMULATE MAINS** signal input. The SPARE digital input may be assigned as **Simulate Mains** using program parameter **P\_46**.

It is also necessary to set the **ACTION** program parameter of the related input to **3** in order to prevent any alarms generated from this input using the program parameter **P\_77**.

The SIMULATE MAINS signal may be a NO or NC contact, switching to either battery positive or battery negative. These selections are made using the programming menu.

If the **Simulate Mains** input is defined and the input signal is active, the mains phases are not monitored and supposed to be inside limits. This will prevent the genset from starting even in case of a mains failure. If the genset is running when the signal is applied, then usual Mains Waiting and Cooldown cycles will be performed before engine stop. When the SIMULATE MAINS signal is present, the front panels mimic diagram's mains LEDs will reflect the mains voltages as present.

When the signal is passive, the unit will revert to normal operation and monitor the mains voltage status.



**The REMOTE START operation overrides SIMULATE MAINS and FORCE TO START operations.**

## 12.3 Delayed Mains Simulation, Battery Charging

The Delayed Mains Simulation feature is used in battery backed up telecom systems where batteries are able to supply the load during a certain period. The genset is requested to run only when battery voltage drops below the critical level. Once the engine runs, the rectifier system starts charging the batteries and the battery voltage goes up immediately. Thus the engine should continue to run a programmed period for effective charging. The critical battery voltage level will be detected by an external unit which provides the digital Simulate Mains signal for the genset control unit.

The unit offers an optional **SIMULATE MAINS** signal input. The **SPARE** digital input may be assigned as **Simulate Mains** using program parameter **P\_47**.

It is also necessary to set the **ACTION** program parameter of the related input to **3** in order to prevent any alarms generated from this input using the program parameter **P\_77**.

The SIMULATE MAINS signal may be a NO or NC contact, switching to either battery positive or battery negative. These selections are made using the programming menu.

If the **Delayed Simulate Mains** program parameter (**P\_47**) is set to 1 and the input signal is active when the genset is not feeding the load, the mains phases are not monitored and supposed to be inside limits. This will prevent the genset from starting when the simulate mains signal is present (batteries charged). The genset will start when mains voltages are out of limits and the simulate mains signal not present.

If the genset is running when the signal is applied, then MAINS SIMULATION will be prevented during **P\_48 Flashing Relay Timer** program parameter. After this, usual Mains Waiting and Cooldown cycles will be performed before engine stop. When the SIMULATE MAINS signal is present, the front panels mimic diagram's mains LEDs will reflect the mains voltages as present.

When the signal is passive, the unit will revert to normal operation and monitor the mains voltage status.



**The REMOTE START operation overrides DELAYED SIMULATE MAINS operation. When both parameters “Remote Start Operation” and “Delayed Simulate Mains” are set then REMOTE START operation mode is performed.**

## 12.4 Service Request Display

This led is designed to help the periodic maintenance of the genset to be made consistently. The periodic maintenance is basically carried out after a given engine hours (for example 200 hours), but even if this amount of engine hours is not fulfilled, it is performed after a given time limit (for example 12 months).



**The SERVICE REQUEST warning has no effect on the genset operation.**

The unit has both programmable engine hours and maintenance period. The engine hours is programmable with 50-hour steps, the time limit is programmable with 1 month steps. If any of the programmed values is zero, this means that the parameter will not be used. For example a maintenance period of 0 months indicates that the unit will request maintenance only based on engine hours, there will be no time limit. If the engine hours is also selected as 0 hours this will mean that the SERVICE REQUEST display will be inoperative.

When the engine hours **OR** the time limit is over, the A14-SERVICE REQUEST warning will occur and the service request relay function will be active.

The service request relay function may be assigned to the auxiliary relay using **Relay Definition** program parameter.



**To turn off the SERVICE REQUEST led, and reset the service period, press the STOP key for 5 seconds.**

The remaining engine hours and the remaining time limit are kept stored in a non-volatile memory and are not affected from power supply failures.

The time and engine hours to service are displayed by pressing the MENU button.

## 12.5 Engine Hour Meter

The unit features a non-erasable incremental engine hour meter. The hour meter information is kept in a non-volatile memory and is not affected from power supply failures.

The engine hours may be displayed by pressing the MENU button.

## 12.6 Software Version Display

Some additional features are installed within consecutive software releases. In order to be sure of the validity of the status of the unit, the software version needs to be known.

The software version may be displayed by pressing the MENU button.



## 12.7 Gas Engine Fuel Solenoid Control

The unit provides a special function for the fuel solenoid control of a gas engine.

The fuel solenoid of a gas engine is different from a diesel engine. It should be opened after the cranking has been started and should be closed between crank cycles. The delay between the crank start and solenoid opening is adjusted using the **Gas Solenoid Delay** program parameter.

The gas engine fuel solenoid relay function may be assigned to the auxiliary relay using **Relay Definition** program parameter.

## 12.8 Single Phase Operation

If the unit is used in a single phase electrical network, it is advised to set the **Single Phase Enable** program parameter to 1.

When **Single Phase Enable** is set to 1, then the unit will measure electrical parameters only on phases **L1** of genset and mains.

Voltage and overcurrent checks will be performed on phases **L1** only.

**Phase voltages L2** and **L3**, as well as phase-to-phase voltages are removed from display screens.

## 13. DECLARATION OF CONFORMITY

The unit conforms to the EU directives  
-2006/95/EC (low voltage)  
-2004/108/EC (electro-magnetic compatibility)

Norms of reference:  
EN 61010 (safety requirements)  
EN 61326 (EMC requirements)

The CE mark indicates that this product complies with the European requirements for safety, health environmental and customer protection.

## 14. MAINTENANCE



**DO NOT OPEN THE UNIT !**  
**There are NO serviceable parts inside the unit.**

Wipe the unit, if necessary with a soft damp cloth. Do not use chemical agents.

## 15. DISPOSAL OF THE UNIT

Following **DIRECTIVE 2002/96/EC OF THE EUROPEAN PARLIAMENT AND OF THE COUNCIL of 27 January 2003 on waste electrical and electronic equipment (WEEE)**, this unit should be stored and disposed separately from the usual waste.

## 16. ROHS COMPLIANCE

The european ROHS directive restricts and prohibits the use of some chemical materials in electronic devices.

Following the “**DIRECTIVE 2011/65/EU OF THE EUROPEAN PARLIAMENT AND OF THE COUNCIL of 8 June 2011 on the restriction of the use of certain hazardous substances in electrical and electronic equipment**”, this product is listed in annex-I under category: “**Monitoring and control instruments including industrial monitoring and control instruments**” and exempted from ROHS directive.

However, Datakom is not using any ROHS uncompliant electronic components in the production. Only the solder contains lead. The switching to unleaded solderin is in progress.

## 17. TROUBLESHOOTING



Below is a basic list of most often encountered troubles. More detailed investigation may be required in some cases.

### **The genset operates while AC mains are OK or continues to operate after AC mains are OK:**

- Check engine body grounding.
- AC mains voltages may be outside programmed limits, measure the phase voltages.
- Check the AC voltage readings by pressing the MENU button.
- Upper and lower limits of the mains voltages may be too tight. Check the parameters **Mains Voltage Low Limit** and **Mains Voltage High Limit**. Standard values are 170/270 volts.
- The hysteresis voltage may be given to excessive. The standard value is 8 volts.

### **AC voltages or frequency displayed on the unit are not correct:**

- Check engine body grounding, it is necessary.
- The error margin of the unit is +/- 3 volts.
- If there are faulty measurements only when the engine is running, there may be a faulty charging alternator or voltage regulator on the engine. Disconnect the charging alternator connection of the engine and check if the error is removed.
- If there are faulty measurements only when mains are present, then the battery charger may be failed. Turn off the rectifier fuse and check again.

### **When the AC mains fails the unit energizes the fuel solenoid, but does not start and A01-OIL PRESSURE warning occurs:**

- The unit is not supplied with battery (-) voltage at the oil pressure input.
- Oil pressure switch not connected.
  - Oil pressure switch connection wire cut.
  - Oil pressure switch faulty.
  - Oil pressure switch closes too lately. If oil pressure switch closes, the unit will start. Optionally oil pressure switch may be replaced.

### **The engine does not run after the first start attempt, then the unit does not start again and A01-OIL PRESSURE warning occurs:**

- The oil pressure switch closes very lately. As the unit senses an oil pressure, it does not start. When oil pressure switch closes the unit will start. Optionally the oil pressure switch may be replaced.

**When the AC mains fails, the engine starts to run but the unit gives A07-START FAIL alarm and then the engine stops:**

-The generator phase voltages are not connected to the unit. Measure the AC voltage between terminals **GEN L1-L2-L3** and **Generator Neutral** at the rear of the unit while the engine is running. A fuse protecting the generator phases may be failed. A misconnection may be occurred. If everything is OK, turn all the fuses off, and then turn all the fuses on, starting from the DC supply fuse. Then test the unit again.

**The unit is late to remove engine cranking:**

-The generator voltage rises lately. Also the generator remnant voltage is below 14 volts. The unit removes starting with the generator frequency, and needs at least 14 volts to measure the frequency. If this situation is to be avoided, please enable crank cutting with oil pressure and charge alternator voltage.

**The unit is inoperative:**

Measure the DC-supply voltage between terminals 2 and 4 at the rear of the unit. If OK, turn all the fuses off and disconnect the battery, then turn all the fuses on and reconnect the battery, then test the unit again.

**Some program parameters are skipped:**

These parameters are reserved for factory setting and cannot be modified.